

TK LIGHTING®



**IT'S
MY
LIGHT**

SPOTLIGHT



2-3 / FIRA



4 / AURA



4 / OPTI



5 / NEXUS



6-7 / PRISMA

DOWNLIGHT



10-11 / FLARE



12-13 / VIVO



14-15 / BLAZE



16-17 / SPARK



18-19 / TOP



20-21 / TWIST

SPOTLIGHT



22-23 / NEX



24-25 / NEX



26-27 / VOX

TRACER



28-43 / ONE-TRACK



44-45 / THREE-TRACK

10573 / FIRA



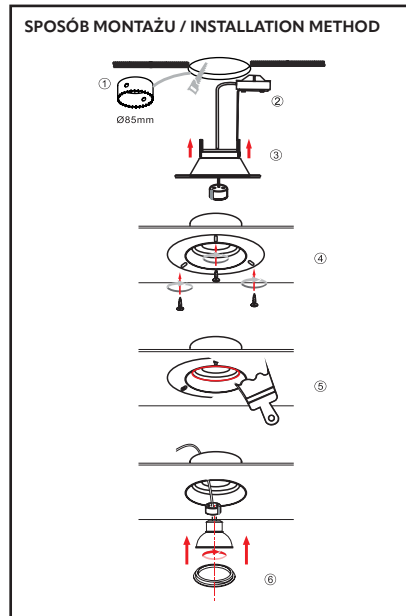
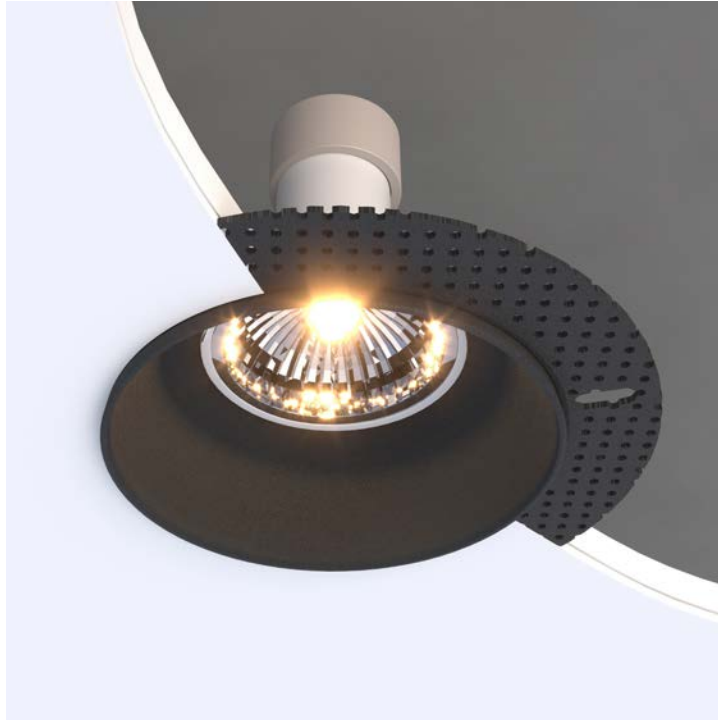

10577 / OPTI

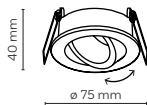

10571 / AURA

1 x GU10 / 230V / max 10W / LED

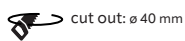

10577 / OPTI

1 x GU10 / 230V / max 10W / LED

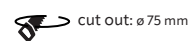



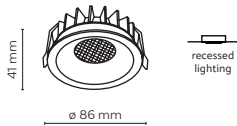

 Anti-glare
 Honeycomb Mesh Cover





18127 / NEXUS



 1x LED / 12W / b-802 lm, w-840 lm
 / CCT 3000-6000K

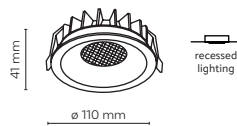

 cut out: \varnothing 75mm



18133 / NEXUS

 1x LED / 18W / b-1106 lm, w-1129 lm
 / CCT 3000-6000K



 cut out: \varnothing 95 mm

10571 / PRISMA





10582 / PRISMA



10579 / PRISMA DUO

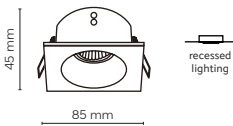

10581 / PRISMA



1 x GU10 / 230V / max 10W / LED



cut out: ø 75 mm

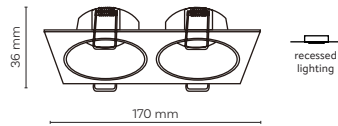

10579 / PRISMA DUO



1 x GU10 / 230V / max 10W / LED



cut out: 156x80 mm

10583 / FLARE

6920 / JET







10584 / FLARE



10583 / FLARE

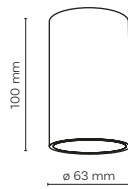

 **10583 / FLARE**

 1 x GU10 / 230V / max 10W / LED

 10583

 10584

 IP44

10595 /VIVO





10594 / VIVO



10595 / VIVO

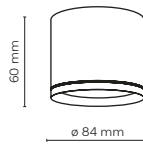

 **10594 / VIVO**

 1 x GX53 / 230V / max 10W / LED

 10594

 10595

 IP44



18140 / BLAZE



Removable Anti-glare
Honeycomb Mesh Cover

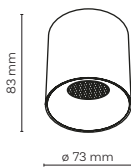

 **18141 / BLAZE**

 1x LED / 12W / b-865 lm, w-913 lm / 3000K



18141 18140

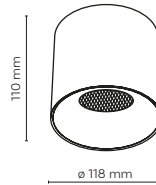

 **18145 / BLAZE**

 1x LED / 30W / b-1609 lm, w-1672 lm / 3000K



18145 18144

 **18158 / BLAZE CCT**

 1x LED / 12W / 500 lm / CCT 3000-6000K



18158 18157

 **18162 / BLAZE CCT**

 1x LED / 30W / 1493 lm / CCT 3000-6000K



18162 18161



18147 / SPARK DUO



Removable Anti-glare
Honeycomb Mesh Cover

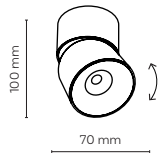

 **18146 / SPARK**

 1x LED / 10W / 513 lm / 3000K



18146

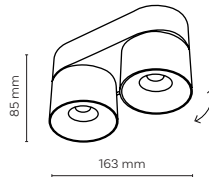

 **18147 / SPARK DUO**

 2x LED / 2x 10W / 1263 lm / 3000K



18147

 **18163 / SPARK CCT**

 1x LED / 10W / 639 lm / CCT 3000-6000K



18163

18168

 **18164 / SPARK DUO CCT**

 2x LED / 2x 10W / 1531 lm / CCT 3000-6000K



18164

18171



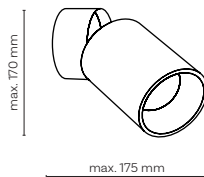

 **5373 / TOP**

 1 x GU10 / 230V / max 10W / LED



 5373  5372

10575 / TWIST

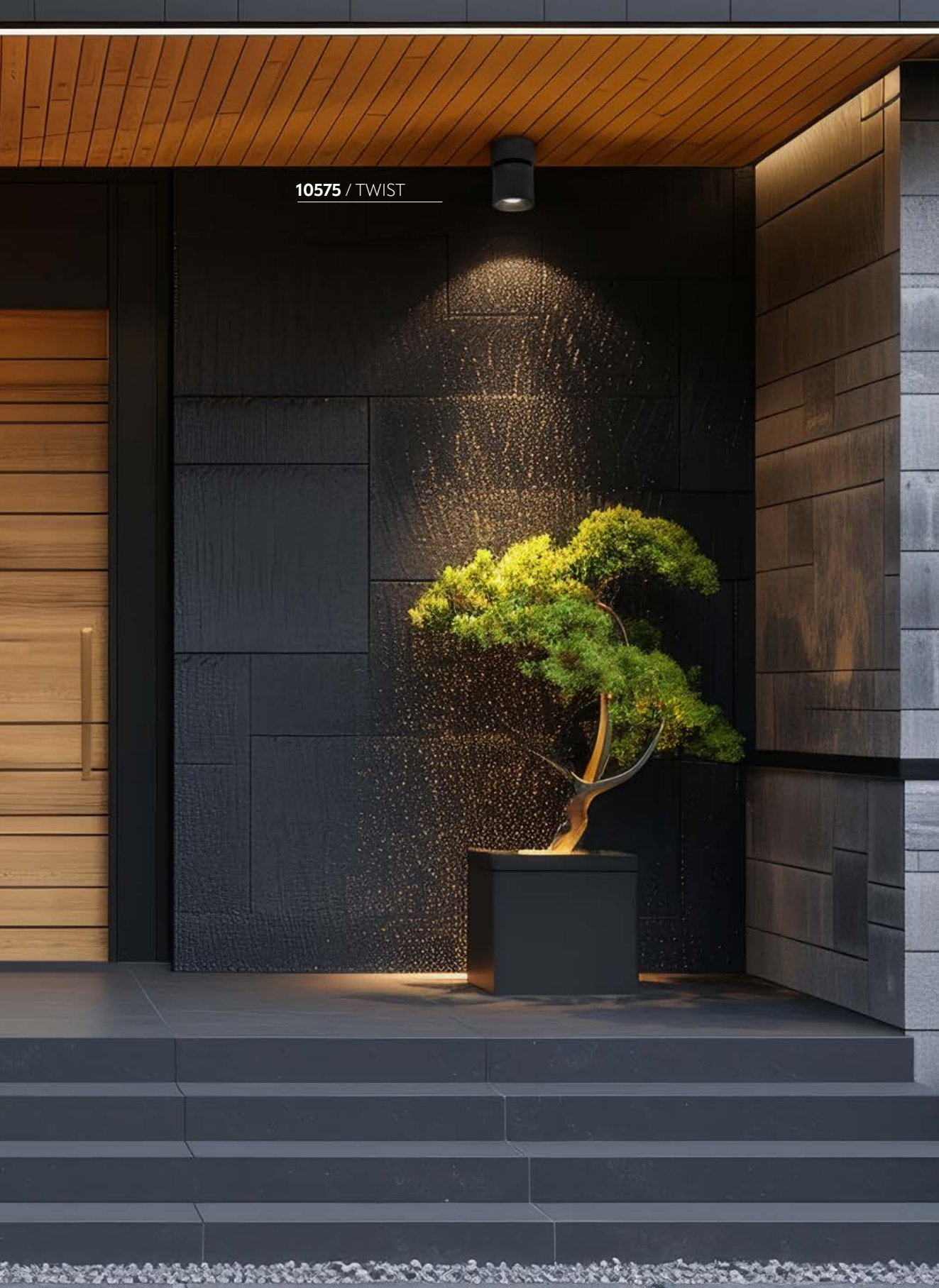



10576 / TWIST



10575 / TWIST

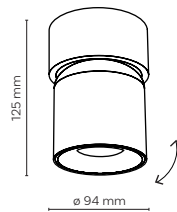

10575 / TWIST

1 x GU10 / 230V / max 10W / LED



10575 10576



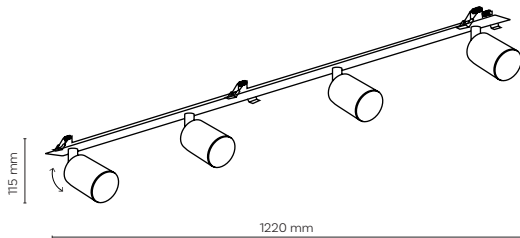

10801 / NEX

4 x GU10 / 230V / max 10W / LED



10801 10805

cut out: 1075x35 mm

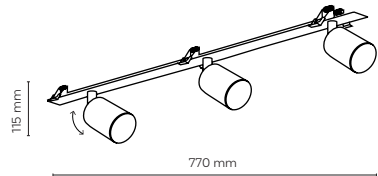

10800 / NEX

3 x GU10 / 230V / max 10W / LED



10800 10804

cut out: 630x35 mm

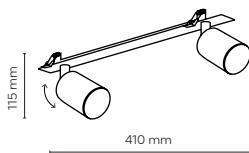

10799 / NEX

2 x GU10 / 230V / max 10W / LED



10799 10803

cut out: 270x35 mm

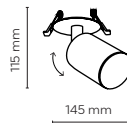

10798 / NEX

1 x GU10 / 230V / max 10W / LED



10798 10802

cut out: 65x35 mm



10791 / NEX

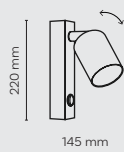

5738 / TOP

1 x GU10 / 230V / max 10W / LED



5738 6186 4872 6087 10747



5739 / TOP

1 x GU10 / 230V / max 10W / LED



5739 6197 5957 6088 10786



5739 / TOP

Kolekcja NEX kompatybilna z kolekcją TOP

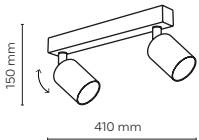

10790 / NEX

2 x GU10 / 230V / max 10W / LED



10790 10787 10628

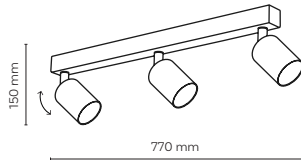

10791 / NEX

3 x GU10 / 230V / max 10W / LED



10791 10788 10629

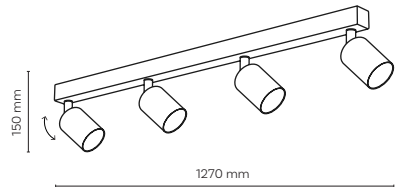

10792 / NEX

4 x GU10 / 230V / max 10W / LED



10792 10789 10630

10003 / VOX





10001 / VOX



10000 / VOX

110 mm
100 mm

1 x G9 / 230V / max 8W / LED
KL / 7455 (ø 100mm)

cut out: 65x35 mm



10927 / VOX

1 x GU10 / 230V / max 10W / LED
+ 1 x G9 / 230V / max 8W / LED
KL / 7455 (ø 100mm)

cut out: 315x35 mm

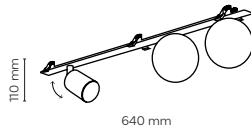

10928 / VOX

1 x GU10 / 230V / max 10W / LED
+ 2 x G9 / 230V / max 8W / LED
KL / 7455 (ø 100mm)

cut out: 525x35 mm

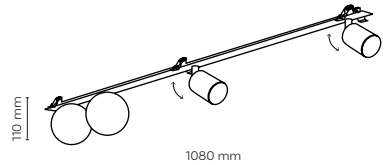

10929 / VOX

2 x GU10 / 230V / max 10W / LED
+ 2 x G9 / 230V / max 8W / LED
KL / 7455 (ø 100mm)

cut out: 975x35 mm

Aksesoria do jednoobwodowych systemów szynowych

Accessories for one-track system



4529

łącznik zasilający prosty
middle feeder straight

4072

łącznik elastyczny
connector flexible

3519

łącznik T
connector T

4045

listwa 1000 mm
1000 mm track

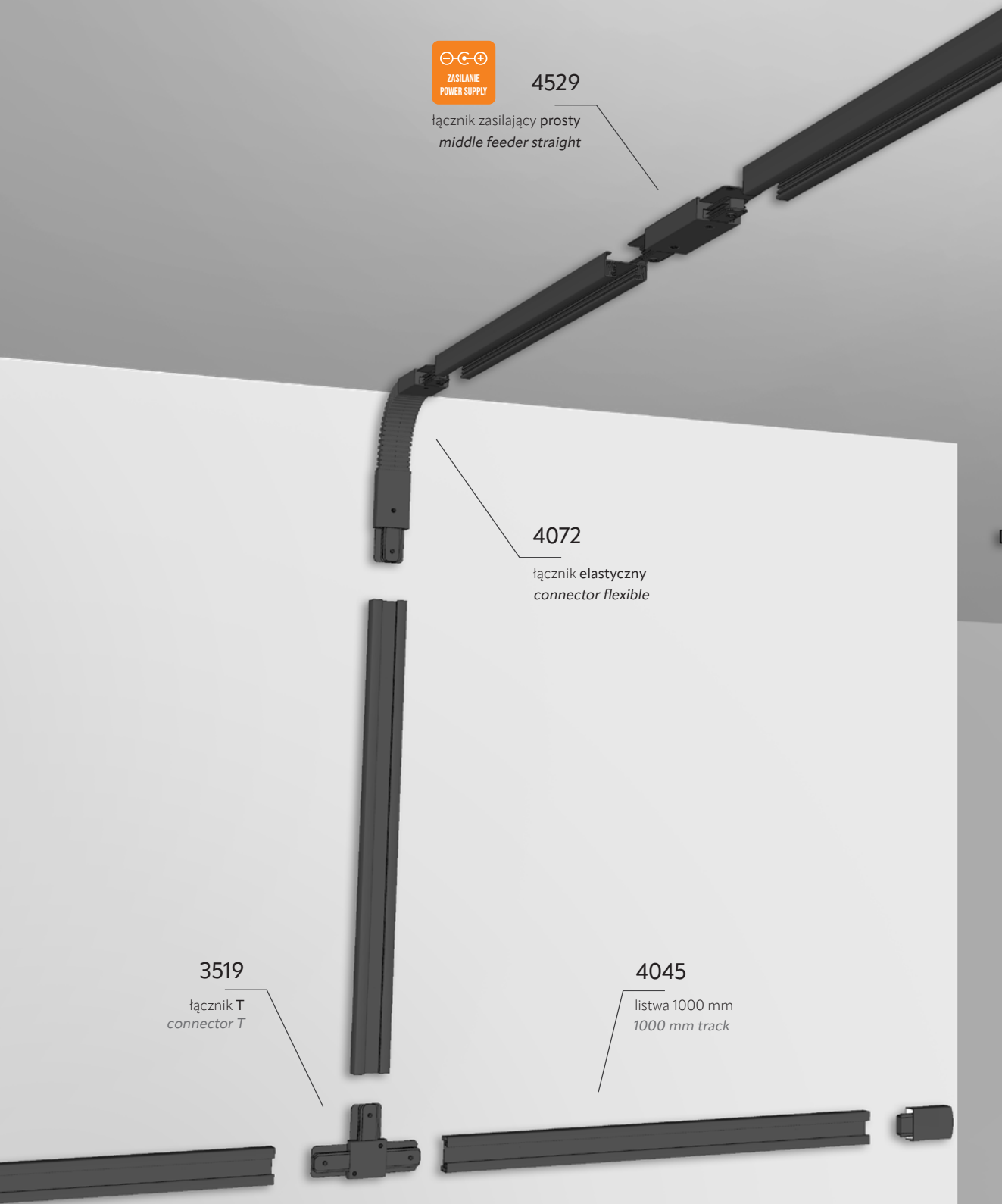

4070

łącznik L
connector L

4143

listwa 2000 mm
2000 mm track

4068

łącznik prosty
connector straight

Elementy zasilające w systemach szynowych / Power supply elements in rail systems

Listwa z zasilaniem długości 1000 mm lub 2000 mm / Power strip 1000 mm or 2000 mm long

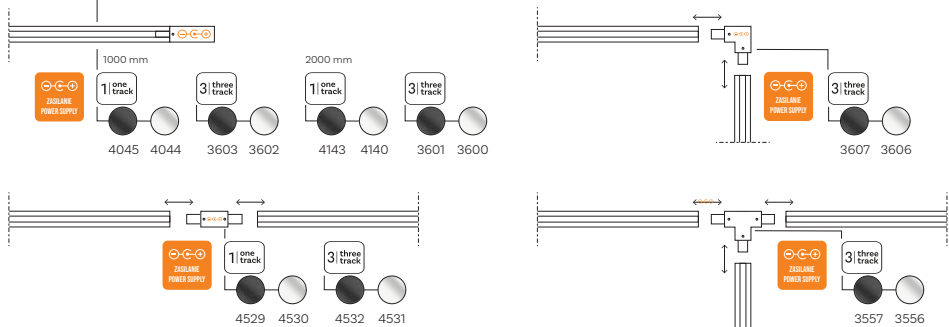

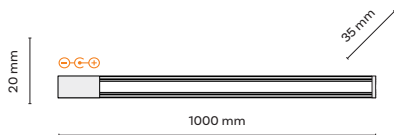

- 1 | one track — ● — ●
4045 4044
- 3 | three track — ● — ● — ●
3603 3602

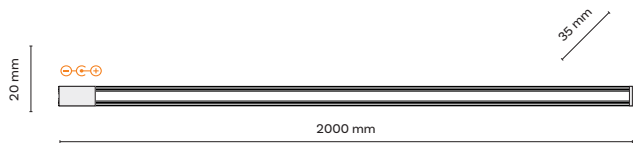

- 1 | one track — ● — ●
4143 4140
- 3 | three track — ● — ● — ●
3601 3600



one track connectors

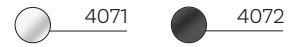
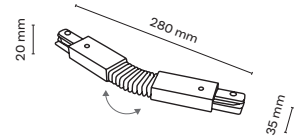
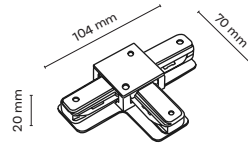
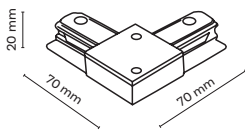
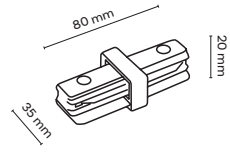
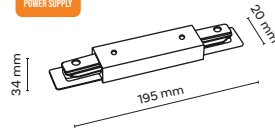

three track connectors

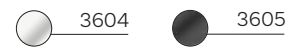
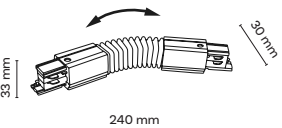
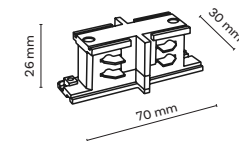
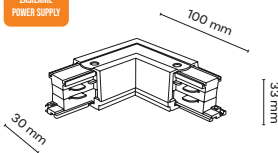
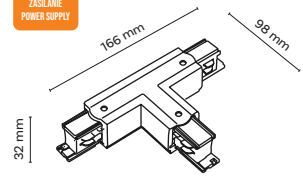
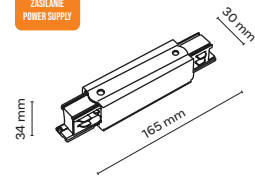



ONE TRACK TRACER



5685

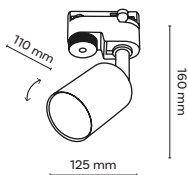

● 5685

● 4921

● 5686



GU10

230V



LED



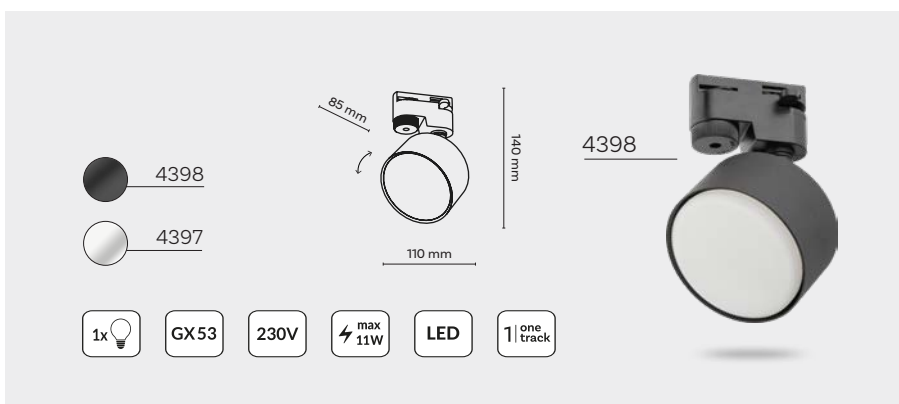
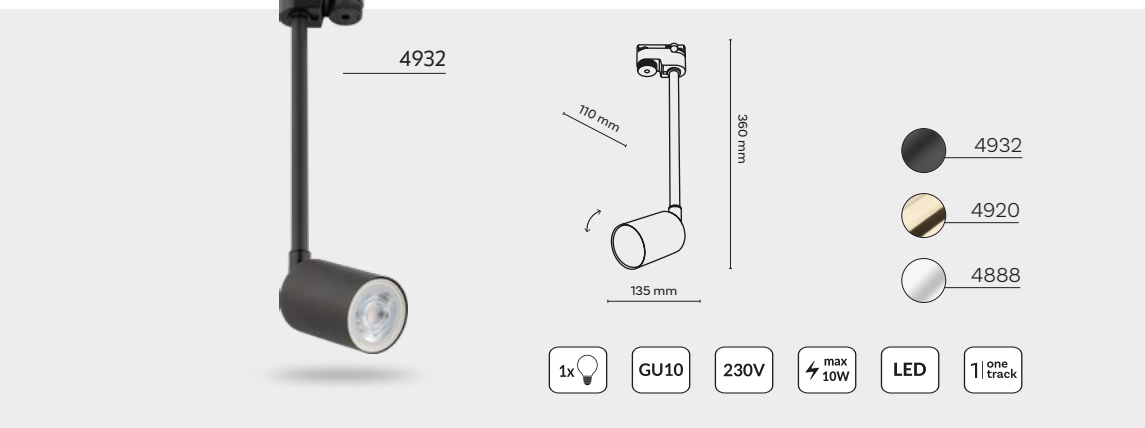
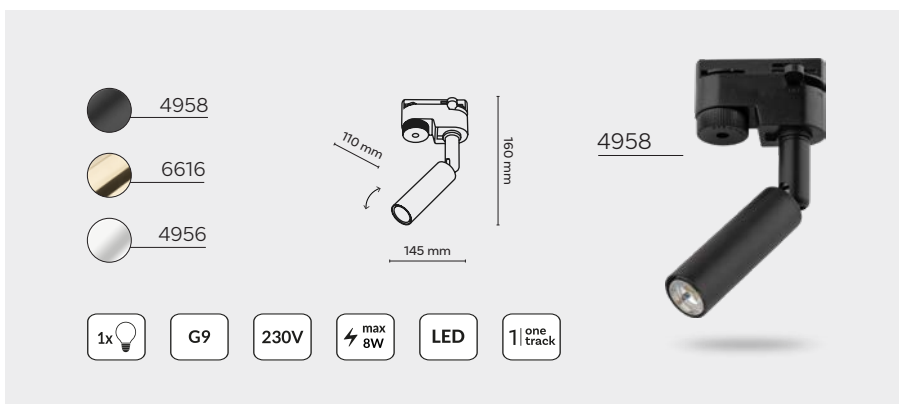

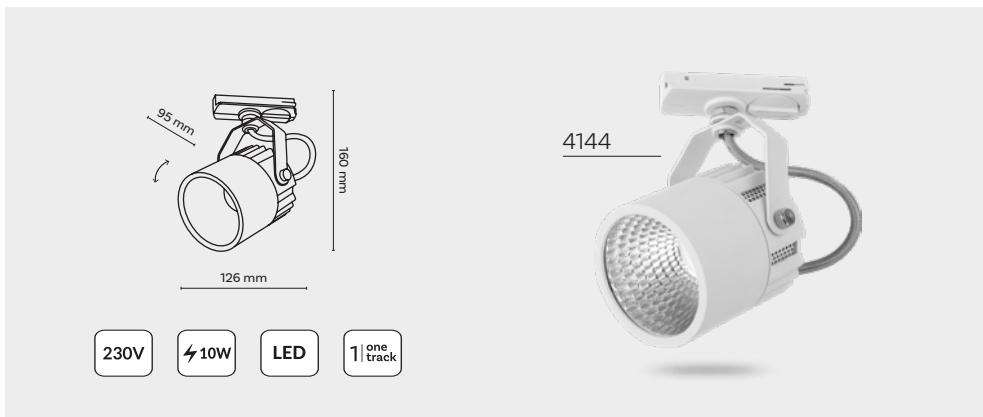
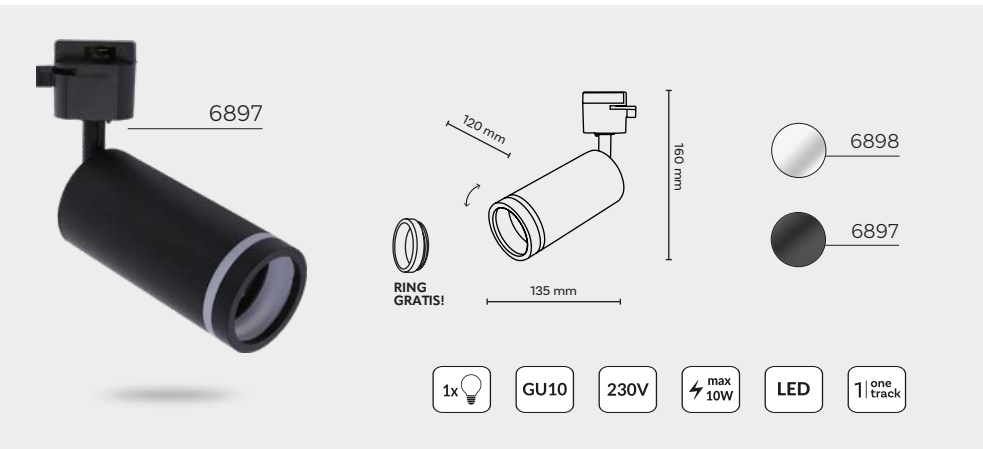
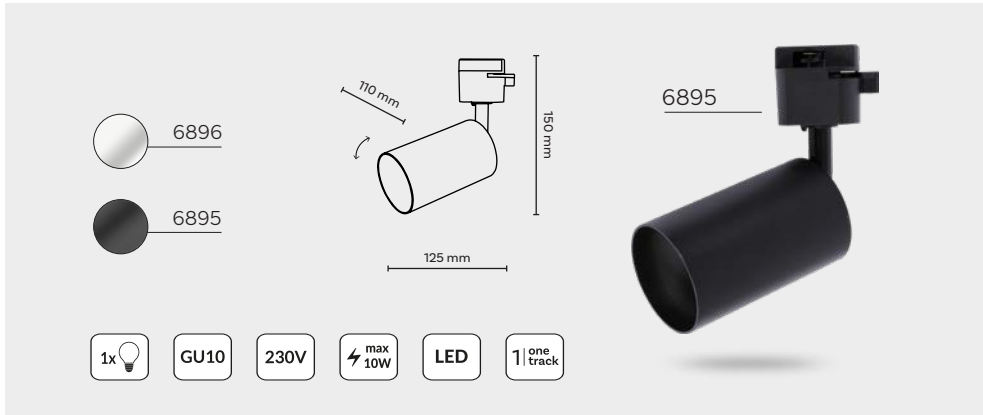



6897
one-track



Zestaw podwieszający
Suspension set

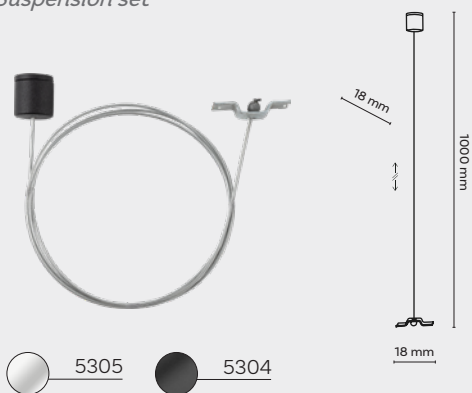

Zestaw zasilający
Power set





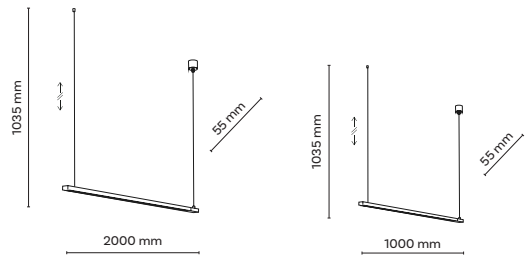

TRACER podwieszany
jednoobwodowy
tracer suspended 1-circuit

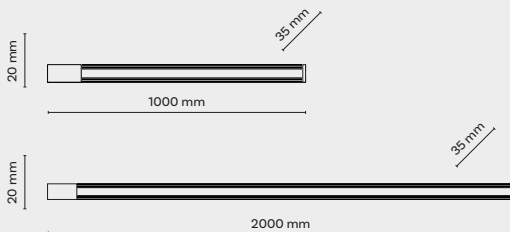

Listwy jednoobwodowe
One-circuit tracks



		
1000 mm	4044	4045
2000 mm	4140	4143

10649*
one-track



10648*
one-track



1x G9 230V max 8W LED 1 one track

4927*
one-track

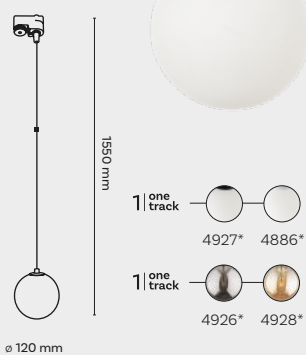

1x G9 230V max 8W LED 1 one track

4923*
one-track



170 mm
ø 120 mm

1 | one track
4923 4887

1 | one track
4922 4924

1x G9 230V

max 8W LED 1 | one track

4929*
one-track

80 mm
1550 mm
52 mm

1x GU10 230V

max 10W LED 1 | one track

5751
one-track



80 mm
1770 mm
35 mm

1 | one track
5751 5750

3 | three track
6028 6029

1x G9 230V

max 8W LED

10650*
one-track



1580 mm
ø 190 mm

1 | one track
10618* 10650* 10655*

10654* 10652* 10651*

1x E27 230V

max 15W LED 1 | one track

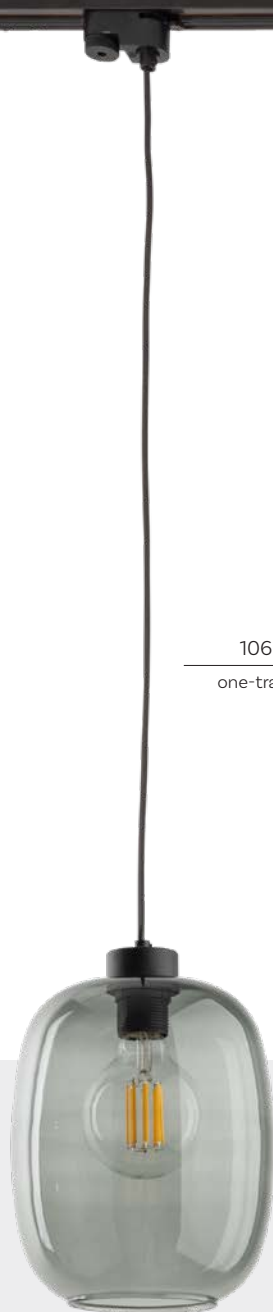

10663*
one-track



10680*
one-track

10666*
one-track



1 one track
10662* 10663* 10664*

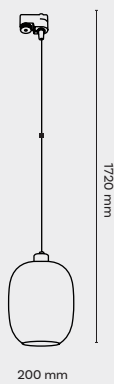

3 three track
10682* 10683* 10684*



1 one track
10665* 10666* 10667*

3 three track
10685* 10686* 10687*



10680
one-track



10675
one-track



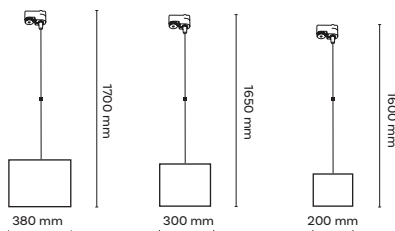

1 | one track

- JUTA
- CHINTZ
- LINEN
- CHINTZ

380 mm	10668*	10669*	10670*	10671*
300 mm	10672*	10673*	10674*	10675*
200 mm	10676*	10677*	10678*	10679*

3 | three track

- JUTA
- CHINTZ
- LINEN
- CHINTZ

380 mm	10688*	10689*	10690*	10691*
300 mm	10692*	10693*	10694*	10695*
200 mm	10696*	10697*	10698*	10699*

THREE-TRACK TRACER

Tracer trójobwodowy daje możliwość oddzielnego sterowania poszczególnymi spotami w szynoprzewodzie. W efekcie można włączyć lub wyłączyć wszystkie lampy bądź też uruchomić konkretne z nich w zależności od preferencji.

The three-circuit tracer gives you the ability to separately control individual spots on a track. As a result, you can turn all the lights on or off, or run specific of them depending on your preference.

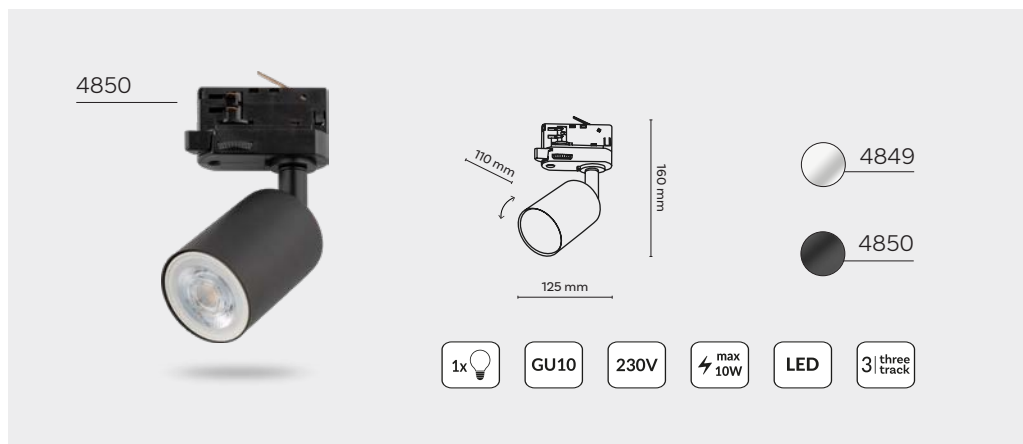

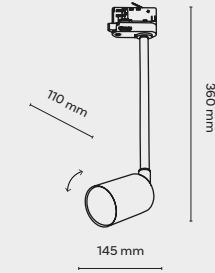
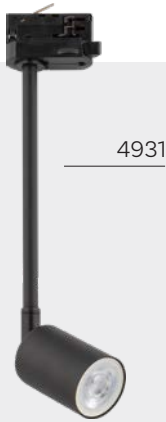
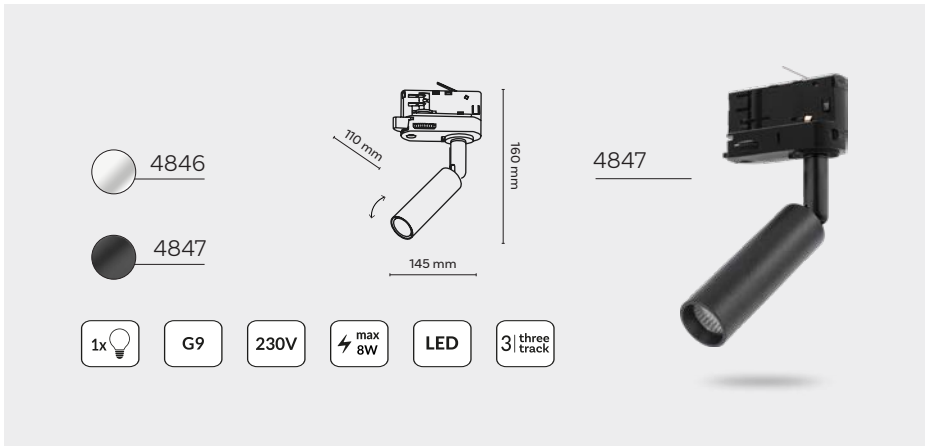

4930

4931

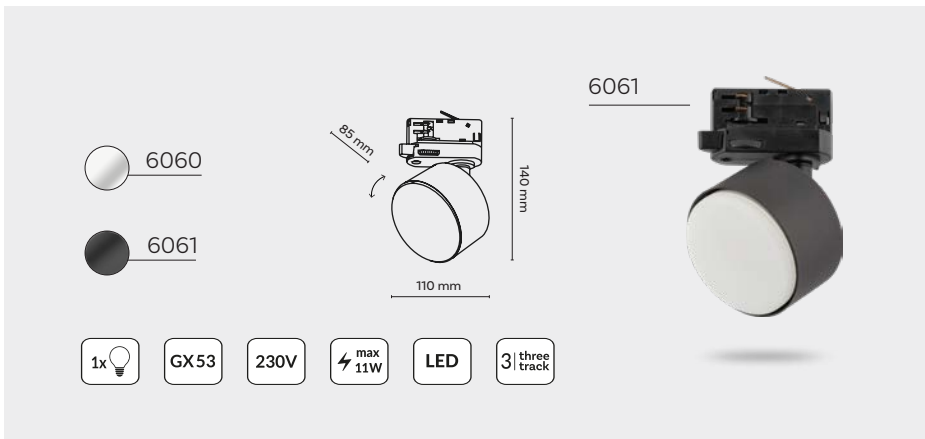







ZRÓDŁO ŚWIATŁA
/ LIGHT SOURCE



LAMPA STOJĄCA
/ FLOOR LAMP



LAMPA WISZĄCA
/ PENDANT LAMP



PLAFON
/ CEILING LAMP



MOŻLIWOŚĆ MONTAŻU
BEZPOŚREDNIO NA SUFICIE
/ POSSIBLE TO MOUNT
DIRECTLY ON THE CEILING



MOŻLIWOŚĆ MONTAŻU
BEZPOŚREDNIO NA ŚCIANIE
/ POSSIBLE TO MOUNT DIRECTLY
ON THE WALL



MONTAŻ TYLKO DO SUFITU
/ CEILING MOUNTING ONLY

RODZAJE MOCOWANIA ŹRÓDŁA ŚWIATŁA
/ BULB SOCKET:



E14



E27



G9



GU10



GX53



LED

RODZAJ ŚWIATŁA
/ TYPE OF LIGHT

KLASA OCHRONNOŚCI PRZED WILGOCIĄ
/ IP CLASS:



IP20

Dla pomieszczeń wewnętrznych bez ryzyka kontaktu z wodą.
/ For indoor spaces without the risk of contact with water.



IP44

Dla umiarkowanie wilgotnych miejsc, takich jak łazienki czy zadaszone przestrzenie zewnętrzne.
/ For moderately humid places, such as bathrooms or covered outdoor spaces.



IP54

Dla pomieszczeń takich jak warsztaty i magazyny, oraz zadaszonych przestrzeni zewnętrznych narażonych na kurz i drobne zachłapania.
/ For spaces such as workshops and warehouses, and covered outdoor areas exposed to dust and minor splashes.



IP65

Dla zewnętrznych instalacji, odpornych na pył i strumienie wody. Idealne na fasady budynków i ogrody.
/ For outdoor installations, resistant to dust and water jets. Ideal for building facades and gardens.



 www.tk-lighting.com



 [@TKLighting_poland](https://www.youtube.com/@TKLighting_poland)



 [/tk_lighting_poland/](https://www.instagram.com/tk_lighting_poland/)



 [/tk_lighting_poland/](https://www.facebook.com/tk_lighting_poland/)



TK LIGHTING®

ul. Bojemskiego 8 d,
42-202 Częstochowa, POLAND
tel: +48 603 579 999,
e-mail: biuro@tk-lighting.eu
www.tk-lighting.com